

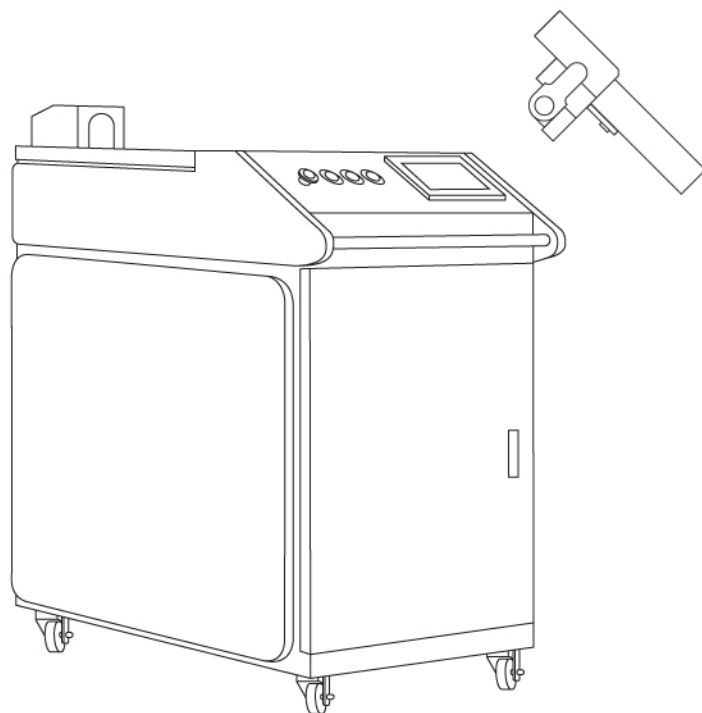

# CW Laser Cleaning Machine

Instruction Manual

ZB-QX1500



## Preface

Thank you for purchasing our products. Please read the installation manual carefully before use and keep it properly.

This installation manual is not a quality guarantee. The correction of printing errors, errata of information errors, and product improvements are subject to interpretation by our company at any time without prior notice. The revised content will be included in the reprinted installation manual.

## Company Profile

Jobon Laser is a high-tech enterprise integrating R&D, production and sales of laser application equipment, specializing in the production of laser welding machines, laser cleaning machines, laser marking machines, laser cutting machines and other laser equipment. Our company has been engaged in the laser field for more than 14 years, with sales services covering 120 countries around the world. We have our own factory, including neat warehouses, standardized workshops and exhibition halls. Welcome to visit us.

Our products are used in a variety of industries including cup and pot hardware, kitchen hardware, bathroom hardware, construction hardware, precision instruments, packaging materials, electronic circuits, instrumentation, computer manufacturing, mobile communications, auto parts, gold and silver jewelry, craft gifts, etc. Our advantage is not just the price, but also the reliable performance that allows us to win the market!

Perfect service network. Customer service response time is within 24 hours. We always pay attention to customer interests. Free training, free maintenance, free technical support, responsible for customers. A maintenance team with superb technology and first-class service solves customers' worries.

**This manual details the installation and use of the Jobon handheld laser welding machine and related operations. Before you unpack, install and use this machine, please pay attention to the following points:**

- The operator should have relevant technical training or be guided by a dedicated person ;
- This manual will help you understand this machine and please operate it according to the regulations ;
- This manual contains many important tips to help you operate safely, economically, adapt to local conditions, and common troubleshooting. If you can follow these tips, you can not only avoid dangerous accidents, reduce maintenance costs, and reduce downtime and maintenance time, but also effectively improve the working life of the machine and reduce the failure rate ;
- The manual should be kept next to the machine for reference at any time.

## Security Requirements

- Improper use of lasers may cause personal injury, so please carefully understand the safety knowledge of laser use before use to avoid personal injury and prevent damage to this product or any other products connected to it. In order to avoid possible dangers, this product can only be used within the specified range;
- Never point the laser towards your own or other people's eyes at any time. Even if the laser is turned off, it may be turned on by mistake;
- Lasers are not toys and should not be used by children, mentally retarded people, or people who do not understand the characteristics of lasers. In such cases, it is very easy to cause harm;
- Since this type of laser is invisible light, it is strictly forbidden to place flammable or explosive items near the equipment to prevent fire caused by the laser being misplaced;
- Product grounding. This product is grounded through the power cord grounding wire. To prevent static electricity from hurting people, the grounding wire must be connected to the ground. Before using this product, make sure that the product is properly grounded;
- Because there are laser and high-voltage parts in the machine, non-professionals are strictly prohibited from disassembling the machine without authorization;
- Do not start the machine when the voltage is unstable, otherwise a voltage stabilizer must be used ;
- The water circulation must be kept clean and purified water must be used. Mineral water and tap water cannot be used;
- If the machine malfunctions or a fire occurs, please cut off the power supply immediately;
- If there is a suspected fault, please do not operate. If you suspect that this product has a fault, please contact our after-sales staff for inspection. Do not operate it privately;
- Do not operate in explosive atmospheres;
- Keep the product surface clean and dry;
- It is recommended that every person working with this machine should read this instruction manual;
- Please strictly follow the instructions and guidance of technical engineers, otherwise the product failure caused will no longer be covered by the warranty.

## CONTENTS

Electronic control system .....	01
Water Cooling System .....	02
Gas system .....	03
Power on .....	04
Remote cleaning .....	05
Shutdown .....	06

## Electronic control system

Power	Voltage
1000-2000W	220V 1PH
3000-6000W	380V 3PH

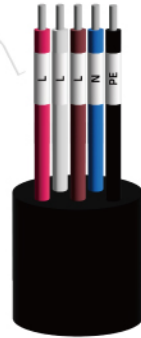

L: Live line  
N: Neutral line  
PE: Protective earth wire

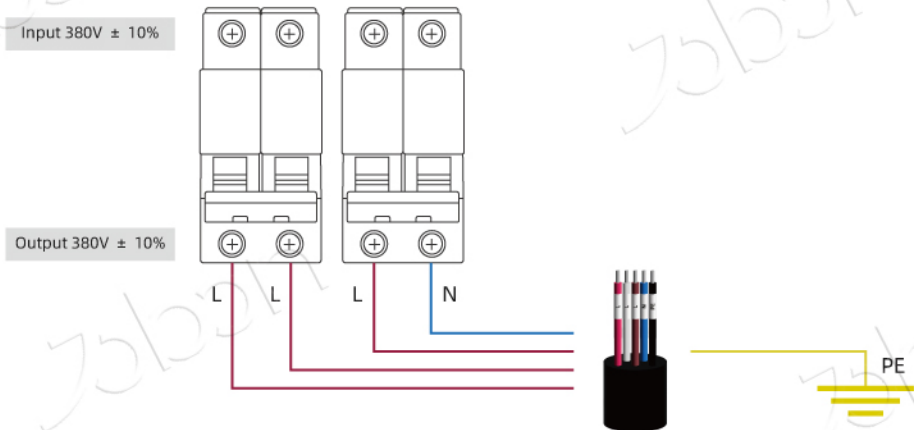

Note: Please wear rubber gloves when turning the air switch upward after connecting the power to prevent electric shock.

- ⚠ The machine voltage is not within  $(220/380) \pm 10$ , or the fluctuation is large and a voltage stabilizer needs to be installed
- ⚠ The ground wire must be effectively grounded separately, and cannot be virtually or ineffectively grounded (industrial grounding requires burying a metal conductor copper block 5m deep in the ground, and then leading the wire out of the ground to complete the loop so that the equipment can meet the required grounding wire)

## Water Cooling System

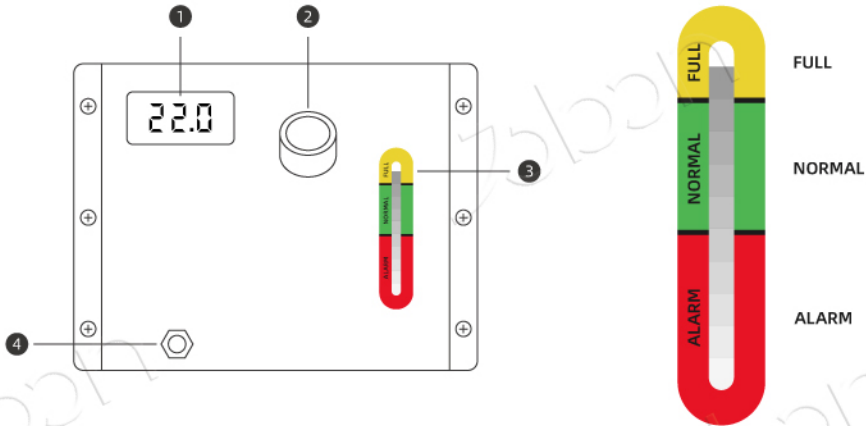

- ① Temperature control display: Temperature  $\geq 22^\circ$  (need to wait for the water tank to heat up);
  - ② Water inlet: Only pure water or distilled water can be added (no mineral water can be added);
  - ③ Water level: Water needs to reach the overflow area and cannot be lower than the standard area;
  - ④ Drainage outlet: It is recommended to drain the water once every two months.
- ⚠ Warning:** When the water temperature is  $\leq 0^\circ$ , you need to add laser professional antifreeze, not car antifreeze (adding car antifreeze will cause water pipe corrosion)
- ⚠ Warning:** When the outdoor temperature is  $>10^\circ$ , the antifreeze needs to be replaced with purified water or distilled water.

Avoid abnormalities of laser source working at low temperature for a long time: the ratio of antifreeze	6:4 (60% antifreeze: 40% water) $-36^\circ \sim -45^\circ$
	5:5 (50% antifreeze: 50% water) $-26^\circ \sim -35^\circ$
	4:6 (40% antifreeze: 60% water) $-16^\circ \sim -25^\circ$
	3:7 (30% antifreeze: 70% water) $-6^\circ \sim -15^\circ$
	2:8 (20% antifreeze: 80% water) $0^\circ \sim -5^\circ$

## Gas system

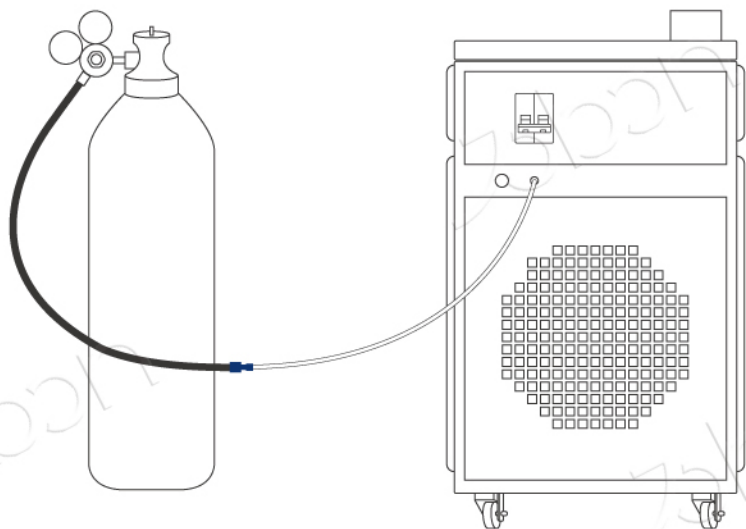

- The gas needs to be nitrogen or argon (high purity 99.99%);
- When using air, you need to install a three-stage filter and a cold dryer (to ensure that the gas is dust-free, oil-free, and water-free) and it can only be used in cleaning mode.

Remote cleaning	Air pressure
	0.5-1.5Mpa

- ⚠ **Warning:** The air pressure valve must use a nitrogen pressure reducing valve, and cannot use an argon pressure reducing valve or an oxygen pressure reducing valve.
- ⚠ **Warning:** Be sure to use the specified gas strictly. Using other gases instead will cause damage to the lens inside the gun body and even burn the optical fiber.

## Power on

- 1 Turn on the air switch to power the machine;
- 2 Rotating emergency stop switch;
- 3 Turn on the system;
- 4 Turn on water cooling (wait for the water tank to heat up to  $\geq 22^{\circ}\text{C}$ );
- 5 Turn on the laser.

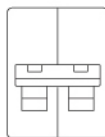

**⚠ Warning:** After turning on the water cooling, you must wait until the water temperature rises above  $22^{\circ}\text{C}$  before turning on the laser



## Remote cleaning

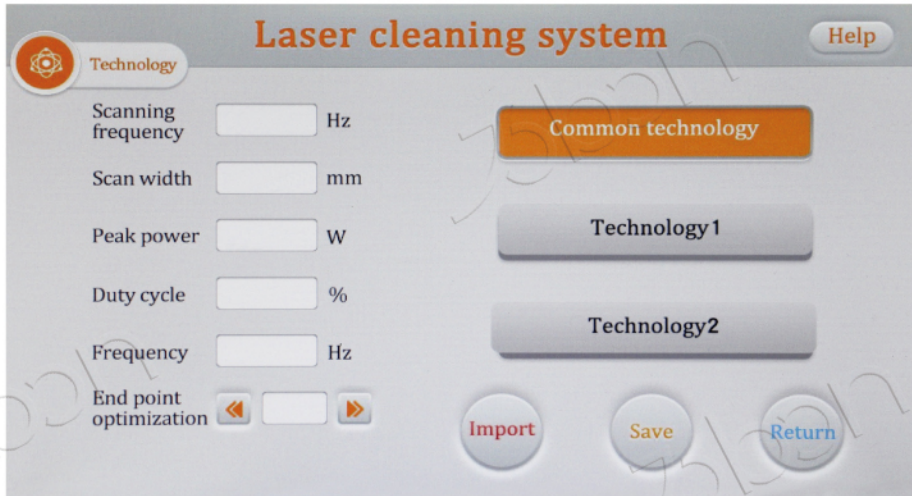

- 1 Adjust Scanning frequency to 100Hz
- 2 Adjust Scan width to 10-300mm
- 3 Adjust Peak power to 100-1500W
- 4 Click Import
- 5 Click Save
- 6 Click Return
- 7 Open the dust cover before cleaning;
- 8 Keep the gun tip 0.6m away from the material for cleaning;
- 9 Double-click the trigger button (long press for the second time) to start cleaning;
- 7 Close the dust cover after cleaning (to prevent dust from entering the gun body, contaminating the lens, and causing damage to the machine).

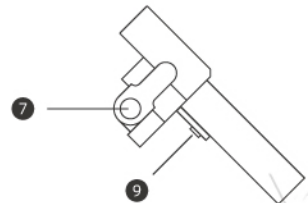

- ⚠ **Warning:** Do not stand in front of the gun when the machine is turned on
- ⚠ **Warning:** When cleaning the gun head, be careful to avoid damaging the internal components

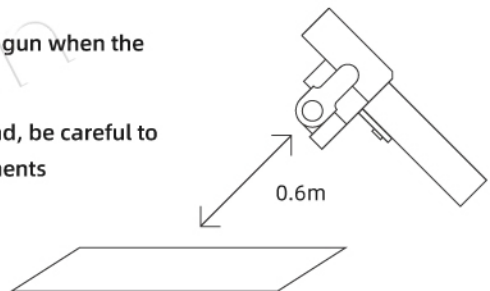

## Shutdown

- 1 Turn off the laser;
- 2 Turn off water chiller;
- 3 Turn off system;
- 4 Press emergency stop.



**JINAN JOBON LASER TECHNOLOGY CO., LTD.**

---

Website: [www.jobonlaser.com](http://www.jobonlaser.com)

Address: Chemical Fiber Factory Road, Jinan, Shandong, China